

---

***VRV* SYSTEM Inverter Air Conditioners**

---

## MODELS

Ceiling-mounted Duct type

**FXTQ80A7VEB****FXTQ100A7VEB**

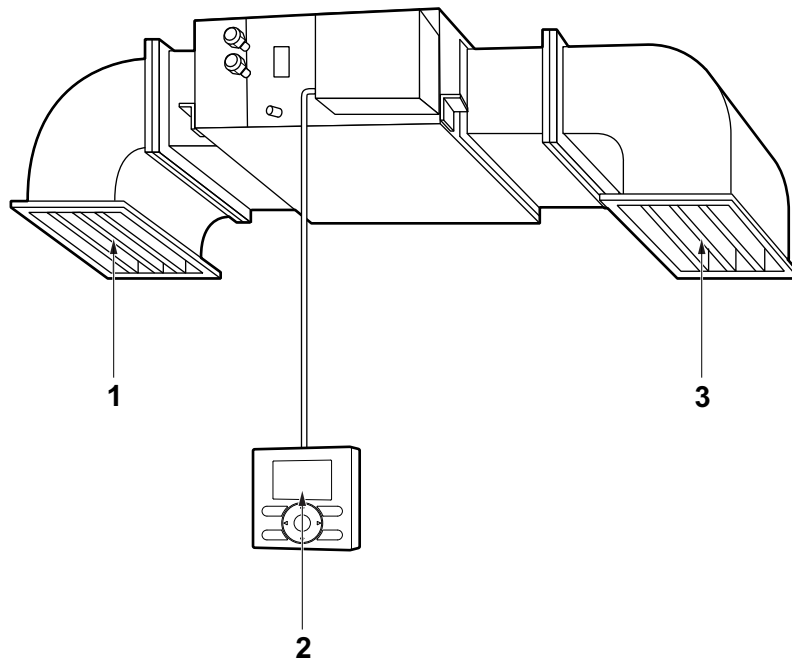

**Fig. 1** (Refer to "2. NAME OF PARTS")

Thank you for purchasing this Daikin air conditioner. Carefully read this operation manual before using the air conditioner. It will tell you how to use the unit properly and help you if any trouble occurs. This manual explains about the indoor unit only. Use it along with the operation manual for the outdoor unit. After reading the manual, file it away for future reference.

Vielen Dank für den Kauf einer Klimaanlage von Daikin. Lesen Sie dieses Betriebshandbuch vor Inbetriebnahme der Klimaanlage sorgfältig durch. Sie erfahren hier, wie die Einheit korrekt genutzt wird, und es ist Ihnen bei Störungen behilflich. Das Betriebshandbuch erklärt nur das Innenaggregat. Verwenden Sie es deshalb zusammen mit dem entsprechenden Handbuch für das Aussenaggregat. Wenn Sie das Handbuch durchgelesen haben, bewahren Sie es gut auf, damit Sie auch später noch nachschlagen können.

Nous vous remercions pour votre acquisition de ce système de climatisation Daikin. Lisez attentivement ce manuel avant d'utiliser le climatiseur. Il vous expliquera comment vous servir correctement de l'appareil et vous guidera en cas de problème. Ce manuel ne décrit que l'unité intérieure. Utilisez-le avec le manuel de l'unité extérieure. Lorsque vous aurez lu le manuel, rangez-le afin de pouvoir vous y référer ultérieurement.

Le agradecemos la compra de este acondicionador de aire Daikin.

Lea cuidadosamente el manual de funcionamiento antes de utilizar el acondicionador de aire. Dicho manual le indicará cómo utilizar adecuadamente la máquina y le ayudará en caso de avería. Este manual describe sólo la unidad interior. Utilice conjuntamente con el manual de instrucciones de la unidad exterior. Después de leer el manual, consérvelo para consultas futuras.

La ringraziamo di aver acquistato questo condizionatore d'aria Daikin

Leggere attentamente questo manuale prima di utilizzare il condizionatore. Contiene le istruzioni per usare correttamente l'unità e per rimediare ad eventuali problemi di funzionamento. Il presente manuale è valido per l'unità interna. Utilizzarlo congiuntamente al manuale d'istruzioni per l'unità esterna. Dopo averlo letto, conservare il manuale per consultazioni future.

Σας ευχαριστούμε που αγοράσατε αυτή την κλιματιστική συσκευή της Daikin.

Διαβάστε προσεκτικά αυτό το εγχειρίδιο χρήσης πριν χρησιμοποιήσετε την κλιματιστική συσκευή. Θα σας εξηγήσει πώς να χρησιμοποιείτε τη μονάδα σωστά και θα σας βοηθήσει αν παρουσιαστεί κάποιο πρόβλημα. Αυτό το εγχειρίδιο περιγράφει μόνο την εσωτερική μονάδα.

Χρησιμοποιήστε το μαζί με το εγχειρίδιο λειτουργίας για την εξωτερική μονάδα. Αφού διαβάσετε το εγχειρίδιο, φυλάξτε το για μελλοντική χρήση.

Wij danken u voor de aankoop van deze Daikin-airconditioner.

Lees deze bedrijfshandleiding aandachtig door voordat u de airconditioner gebruikt. Het omvat uitleg over het correcte gebruik van de unit en biedt hulp in geval een storing mocht optreden. Deze handleiding beschrijft alleen het binnentoestel. Gebruik ze samen met de bedieningshandleiding voor het buitentoestel. Gebruik deze handleiding voor verdere raadpleging.

Obrigado pela sua compra deste aparelho de ar condicionado Daikin.

Leia com atenção este manual de operação antes de proceder à utilização do aparelho de ar condicionado. Este indicar-lhe-á como deverá utilizar a unidade correctamente e ajudá-lo-á no caso de surgir qualquer problema. Este manual apenas contém explicações sobre a unidade interior. Use-o em conjunto com o manual de operação da unidade exterior. Depois de ler o manual, guarde-o a fim de o poder consultar caso venha a ser preciso.

Благодарим за покупку кондиционера Daikin. До начала работы с кондиционером внимательно изучите данное руководство по эксплуатации. В нем излагаются правила пользования и приводятся рекомендации по поиску и устранению неисправностей. В данном руководстве рассматривается только комнатный блок. Используйте его вместе с руководством для наружного блока. После изучения руководства сохраните его для справки.

## CONTENTS

ILLUSTRATION .....	[1]
1. SAFETY PRECAUTIONS .....	1
2. NAME OF PARTS .....	3
3. MAINTENANCE (FOR SERVICE PERSONNEL) .....	3
4. SOUND PRESSURE LEVEL .....	4

The original instructions are written in English. All other languages are translations of the original instructions.

### Important information regarding the refrigerant used

This product contains fluorinated greenhouse gases.

Refrigerant type	R410A
GWP <sup>(1)</sup> value	2087.5

<sup>(1)</sup> GWP = global warming potential

Periodical inspections for refrigerant leaks may be required depending on European or local legislation. Please contact your local dealer for more information.

## 1. SAFETY PRECAUTIONS

To gain full advantage of the air conditioner's functions and to avoid malfunction due to mishandling, please read this operation manual carefully before use.

This product comes under the term "appliances not accessible to the general public".

**This appliance is intended to be used by expert or trained users in shops, in light industry and on farms, or for commercial use by lay persons.**

**This appliance can be used by children aged from 8 years and above and persons with reduced physical, sensory or mental capabilities or lack of experience and knowledge if they have been given supervision or instruction concerning use of the appliance in a safe way and understand the hazards involved. Children shall not play with the appliance. Cleaning and user maintenance shall only be done by persons described in manual.**

The appliance is not intended for use by unattended young children or persons who are incompetent to operate air conditioners.

It may result in injury or electric shocks.

- **This manual classifies the precautions into WARNINGS and CAUTIONS. Be sure to follow all the precautions below: They are all important for ensuring safety.**

 **WARNING** ..... Indicates a potentially hazardous situation which, if not avoided, could result in death or serious injury.

 **CAUTION** ..... Indicates a potentially hazardous situation which, if not avoided, may result in minor or moderate injury. It may also be used to alert against unsafe practices.

- **After reading, keep this manual in a convenient place so that you can refer to it whenever necessary. If the equipment is transferred to a new user, be sure also to hand over the manual.**

 **WARNING** .....

**When the air conditioner is malfunctioning (giving off a burning odor, etc.), turn off the power to the air conditioner and contact your local dealer.**

Continued operation under such circumstances may result in a failure, electric shocks or a fire.

**Consult your local dealer regarding modification, repair and maintenance of the air conditioner.**

Improper workmanship may result in water leakage, electric shocks or a fire.

**Be sure to use fuses with the correct ampere reading.**

Do not use improper fuses, copper or other wiring as a substitute, as this may result in electric shocks, a fire, injury or damage to the air conditioner.

**Consult your local dealer if the air conditioner submerges owing to a natural disaster, such as a flood or typhoon.**

Do not operate the air conditioner in that case, or otherwise a malfunction, electric shocks, or a fire may result.

**Start or stop the air conditioner with the remote controller. Never use the power circuit breaker for this purpose.**

Otherwise, it may cause a fire or water leakage.

Furthermore, if an automatic restart control is provided against power failure and the power is recovered, the fan will rotate suddenly and may cause injury.

**Do not use the air conditioner in the atmosphere contaminated with oil vapor, such as cooking oil or machine oil vapor.**

Oil vapor may cause crack damage to the air conditioner, electric shocks, or a fire.

**Do not use flammable materials (e.g., hairspray or insecticide) near the air conditioner.**

**Do not clean the air conditioner with organic solvents such as paint thinner.**

The use of organic solvents may cause crack damage to the air conditioner, electric shocks, or a fire.

**Do not use the air conditioner in places with excessive oily smoke, such as cooking rooms, or in places with flammable gas, corrosive gas, or metal dust.**

Using the air conditioner in such places may cause a fire or air conditioner failures.

**Beware of a fire in case of refrigerant leakage.**

If the air conditioner is not operating correctly, i.e. not generating cool or warm air, refrigerant leakage could be the cause. Consult your local dealer for assistance. The refrigerant used for the air conditioner is safe and normally does not leak. However, if the refrigerant leaks and gets in contact with a naked burner, heater or cooker, it may generate hazardous compounds. Turn off the air conditioner and call your local dealer. Turn on the air conditioner after the qualified service person makes sure to confirm that the leakage is repaired.

**Do not place objects, including rods, your fingers, etc., in the air inlet or outlet.**

Injury may result due to contact with the air conditioner's highspeed fan blades.

**Consult your local dealer regarding cleaning the inside of the air conditioner.**

Improper cleaning may cause breakage of plastic parts, water leakage and other damage as well as electric shocks.

**Be aware that prolonged, direct exposure to cool or warm air from the air conditioner, or to air that is too cool or too warm can be harmful to your physical condition and health.**

**Consult your local dealer about installation work.**

Doing the work yourself may result in water leakage, electric shocks or a fire.

**Contact professional personnel about attachment of accessories and be sure to use only accessories specified by the manufacturer.**

If a defect results from your own workmanship, it may result in water leakage, electric shocks or a fire.

**Consult your local dealer regarding relocation and reinstallation of the air conditioner.**

Improper installation work may result in leakage, electric shocks or a fire.

**Be sure to earth the air conditioner.**

Do not earth the air conditioner to a utility piping, lightning conductor or telephone earth lead. Imperfect earthing may result in electric shocks or a fire. A high surge current from lightning or other sources may cause damage to the air conditioner.

**Be sure to install an earth leakage breaker.**

Failure to install an earth leakage breaker may result in electric shocks or a fire.

**Be sure to use a dedicated power supply for the air conditioner.**

The use of any other power supply may cause heat generation, a fire, or air conditioner failures.

**Consult your local dealer regarding what to do in case of refrigerant leakage.**

When the air conditioner is installed in a small room, it is necessary to take proper measures so that the amount of any leaked refrigerant does not exceed the concentration limit in the event of a leakage. Otherwise, this may lead to an accident due to oxygen depletion.

---

 **CAUTION**

**Children should be watched so that they do not play with the indoor unit or its remote controller.**

Accidental operation by a child may result in injury or electric shocks.

**Do not allow a child to mount on the outdoor unit or avoid placing any object on it.**

Falling or tumbling may result in injury.

**Do not let children play on or around the outdoor unit.**

If they touch the unit carelessly, injury may be caused.

**Be sure that children, plants or animals are not exposed directly to airflow from the indoor unit, as adverse effects may ensue.**

**Do not place flammable sprays or operate spray containers near the air conditioner as this may result in a fire.**

**Do not wash the air conditioner or the remote controller with water, as this may result in electric shocks or fire.**

**Do not place water containers (flower vases, etc.) on the indoor unit, as this may result in electric shocks or a fire.**

**Do not put flammable containers, such as spray cans, within 1 m from the air outlet.**

The containers may explode because the warm air from the indoor or outdoor unit will affect them.

**Turn off the power when the air conditioner is not used for long periods of time.**

Otherwise, the air conditioner may get hot or catch on a fire due to dust accumulation.

**Do not place objects in direct proximity of the outdoor unit and do not let leaves and other debris accumulate around the unit.**

Leaves are a hotbed for small animals which can enter the unit. Once in the unit, such animals can cause malfunctions, smoke or a fire when making contact with electrical parts.

**Before cleaning, be sure to stop the air conditioner operation, turn the power circuit breaker off.**

Otherwise, an electric shocks and injury may result.

**To avoid electric shocks, do not operate with wet hands.**

**Never touch the internal parts of the remote controller.**

Touching certain internal parts will cause electric shocks and damage to the remote controller. Consult your local dealer about checking and adjustment of internal parts.

**To avoid oxygen deficiency, ensure that the room is adequately ventilated if equipment such as a burner is used together with the air conditioner.**

**Do not leave the remote controller wherever there is a risk of wetting.**

If water gets into the remote controller there is a risk of electrical leakage and damage to electronic components.

**Watch your steps at the time of air filter cleaning or inspection.**

High-place work is required, to which utmost attention must be paid.

If the scaffold is unstable, you may fall or topple down, thus causing injury.

**Do not remove the outdoor unit's outlet side grille.**

The grille protects against the unit's high speed fan, which may cause injury.

**To avoid injury, do not touch the air inlet or aluminum fins of the air conditioner.**

**Do not place objects that are susceptible to moisture directly beneath the indoor or outdoor units.**

Under certain conditions, condensation on the unit or refrigerant piping, air filter dirt or drain blockage may cause dripping, resulting in fouling or failure of the object concerned.

**Do not place heaters directly below the indoor unit, as resulting heat can cause deformation.**

**Do not place appliances that produce naked flames in places exposed to the airflow from the air conditioner as this may impair combustion of the burner.**

**Do not block air inlets nor outlets.**

Impaired airflow may result in insufficient performance or trouble.

**Do not use the air conditioner for purposes other than those for which it is intended.**

Do not use the air conditioner for cooling precision instruments, food, plants, animals or works of art as this may adversely affect the performance, quality and/or longevity of the object concerned.

**Do not install the air conditioner at any place where there is a danger of flammable gas leakage.**

In the event of a gas leakage, build-up of gas near the air conditioner may result in a fire.

**Carry out drain piping properly to ensure complete drainage.**

If drain piping is not carried out properly, drain will not flow out. Then, dirt and debris may be accumulated in the drain piping and may cause water leakage. If it occurs, stop the air conditioner and call your local dealer for assistance.

## NOTE TO SERVICE PERSONNEL

### WARNING

- Before inspection (of the control box, fan motor, auxiliary electric heater, drain pump etc.) ensure the power to the air-conditioner and auxiliary heater is disconnected to avoid electric shock.
- When cleaning the heat exchanger, remove the control box, fan motor, auxiliary electric heater and drain pump.  
Water or detergent may deteriorate the insulation of the electrical components, resulting in component failure.

### CAUTIONS

- When servicing, see below and remove the appropriate panel depending on the purpose of the work to be done.
- Do not remove multiple panels at the same time.
- Do not remove the panel on the opposite side to this one.

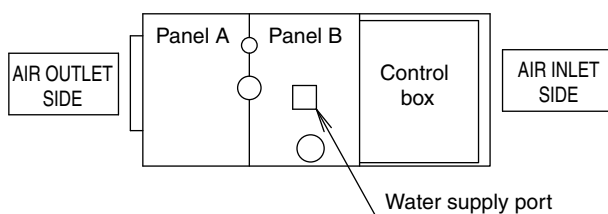

- See below and remove the appropriate panel depending on the purpose of the work to be done.

The purpose of the work to be done	Panel
To check the electrical parts of the heat exchanger.	Panel B
To service the fan assy.	Panel B + Control box
To check the drainage.	Water supply port
To clean the drain pan.	Panel A + Panel B

## 2. NAME OF PARTS

Refer to figure 1 on page [1]

1. Air outlet
2. Remote controller
3. Air inlet

## 3. MAINTENANCE (FOR SERVICE PERSONNEL)

### WARNING

- Only a qualified person is allowed to perform maintenance without daily maintenance.
- Before touching any of connection wirings, be sure to turn off all power supply switches.
- Do not use flammable materials (e.g., hairspray or insecticide) near the product.  
Do not clean the product with organic solvents such as paint thinner.  
The use of organic solvents may cause crack damage to the product, electric shocks, or fire.
- Contact professional personnel about attachment of accessories and be sure to use only accessories specified by the manufacturer.  
If a defect results from your own workmanship, it may result in water leaks, electric shock or fire.
- Consult your dealer regarding cleaning the inside of the air conditioner.  
Improper cleaning may cause breakage of plastic parts, water leakage and other damage as well as electric shocks.

### CAUTION

- Before cleaning, be sure to stop unit operation, turn the breaker off or remove the power cord.  
Otherwise, an electric shock and injury may result.
- Do not wash the air conditioner with water, as this may result in electric shocks or fire.
- Watch your steps at the time of air filter cleaning or inspection.  
High-place work is required, to which utmost attention must be paid.  
If the scaffold is unstable, you may fall or topple down, thus causing injury.

## HOW TO CLEAN THE AIR FILTER

(The air filter is an optional accessory.)

Clean the air filter when the display shows "  " (TIME TO CLEAN AIR FILTER).

Increase the frequency of cleaning if the unit is installed in a room where the air is extremely contaminated.

(As a yardstick for regulating yourself, consider cleaning the filter.)

### 1. Remove the air filters.

### 2. Clean the air filter.

Use vacuum cleaner **A)** or wash the air filter with water **B)**.

**A)** Using a vacuum cleaner



**B)** Washing with water

To clean the air filter, use soft brush and neutral detergent.



Remove water and dry in the shade.

**NOTE** 

- Do not wash the air conditioner with hot water of more than 50°C. Doing so may result in discoloration or deformation.
- Never dry the filter by direct firing. Doing so may result in burning.

**3. Fix the air filter.****4. Turn off the indication "  " (TIME TO CLEAN AIR FILTER) displayed on the remote controller after turning on the power.**

(For details, see the operation manual for the outdoor unit.)

**NOTE** 

- Do not remove the air filter except when cleaning. Unnecessary handling may damage the filter.

**HOW TO CLEAN AIR OUTLET**

1. Clean with soft cloth.
2. When it is difficult to remove stains, use water or neutral detergent.

**NOTE** 

- Do not use gasoline, benzene, thinner, polishing powder, liquid insecticide. It may cause discoloring or warping.
- Do not let the indoor unit get wet. It may cause an electric shock or a fire.
- Do not use hot water of 50°C or higher, as doing so may result in discoloration or deformation.

**4. SOUND PRESSURE LEVEL**

- Sound pressure level is less than 70 dB(A).

ERC

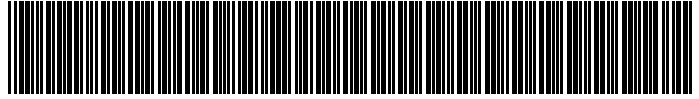

\*4P408657-1 000000S\*

Copyright 2015 Daikin

**DAIKIN EUROPE N.V.**

Zandvoordestraat 300, B-8400 Oostende, Belgium

4P408657-1 2015.06